

Technical data sheet

Pipe sleeve with 12 fastening straps

Item number: 7202218

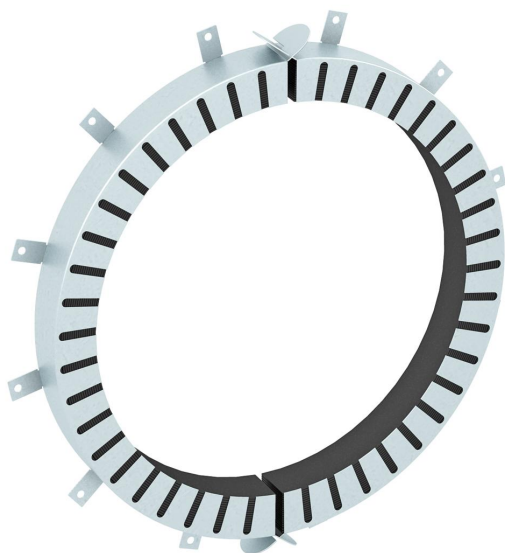

Pipe sleeve for combustible pipes.

If there is a fire, fire protection inserts inside the sheet steel housing expand, exerting a very great pressure onto the burning thermoplastic pipes. For interior application. Fastening with anchors or M8 threaded rods.



Intumescent material

FS Strip galvanized

Master data

Item number	7202218
Type	TCX-315
Description 1	Pipe sleeve
Description 2	for combustible pipes
Manufacturer	OBO
Dimension	Ø315mm
Material	Intumescent material
Surface	Strip galvanized
Surface standard	DIN EN 10346
Smallest sales unit	1
Unit of quantity	Piece
Weight	425 kg
Weight unit	kg/100 pc.

Technical data sheet

Pipe sleeve with 12 fastening straps

Item number: 7202218



Dimensions

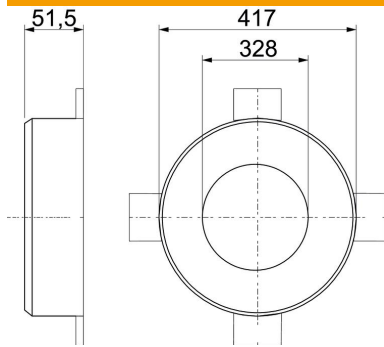

Length	417 mm
Width	417 mm
Height	51.5 mm
Dimension d	328 mm
Dimension d min.	417 mm
Dimension h	51.5 mm

Technical data

Shape	Round
For pipe diameter, max.	317 mm
For pipe diameter, min.	315 mm
Collar lock	Connector
With fastening material	no
Accessories required	yes