

Technical data sheet

Cover, angle-adjustable bend A2

Item number: 6037570



Cover for angle-adjustable bend fitting for lockable and screw-on cable trays in indoor and outdoor areas, to protect cables against damage and soiling. Fastening with pre-mounted sash locks and through attachment of the section cover. Suitable for all side heights.

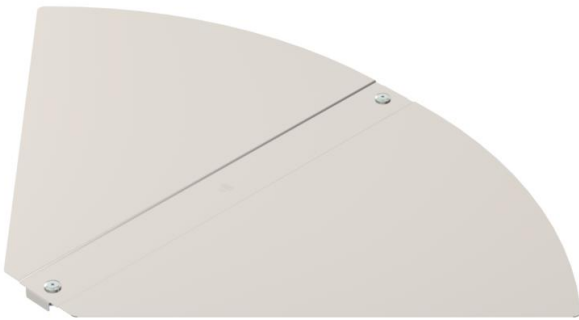

A2 Stainless steel

2B Bright, treated

Master data

Item number	6037570
Type	RBD W 600 A2
Description 1	Cover
Description 2	for bend, adjustable
Manufacturer	OBO
Dimension	B600mm
Material	Stainless steel
Surface	Bright, treated
Surface standard	
Smallest sales unit	1
Unit of quantity	Piece
Weight	274 kg
Weight unit	kg/100 pc.

Technical data sheet

Cover, angle-adjustable bend A2

Item number: 6037570

Dimensions

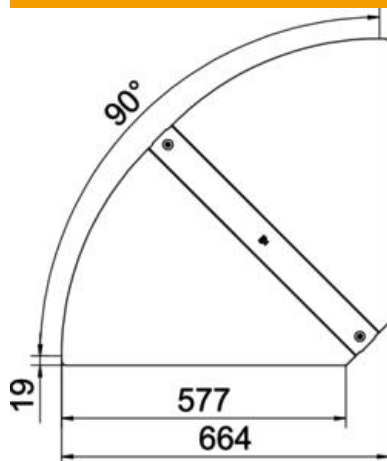

Width	600 mm
Plate thickness	1 mm

Technical data

Bend (angle)	Adjustable
Number of turn buckles	2 St.
Fastening type	Sash lock
Maintain electrical functions	no
Suitable for mesh cable tray	no
Suitable for cable ladder	no
Suitable for cable tray	yes
Change of direction	Horizontal
Rustproof steel, pickled	no
Hinged	no
Permitted temperature range, max.	120 °C
Permitted temperature range, min.	-20 °C