

Technical data sheet

Clamp clip 2056 N-foot, 1-fold, plastic pressure sleeve, A2

Item number: 1188108



Clamp clip with N-foot, plastic pressure sleeve made of polypropylene. For vertical and horizontal mounting of 1 single cable on a C-profile rail. For slot width 11–12 mm With 1-start screw thread on pressure sleeve, universal hexagonal screw head WAF10, with slot and cross recess. Suitable for assembly indoors and outdoors. We recommend the use of a counter-sleeve.



A2 Stainless steel

2B Bright, treated

Master data

Item number	1188108
Type	BS-N1-K-16 A2
Description 1	Clamp clip 2056
Manufacturer	OBO
Dimension	12-16mm
Material	Stainless steel
Surface	Bright, treated
Surface standard	
Smallest sales unit	50
Unit of quantity	Piece
Weight	2.919 kg
Weight unit	kg/100 pc.

Technical data sheet

Clamp clip 2056 N-foot, 1-fold, plastic pressure sleeve, A2



Item number: 1188108

Dimensions

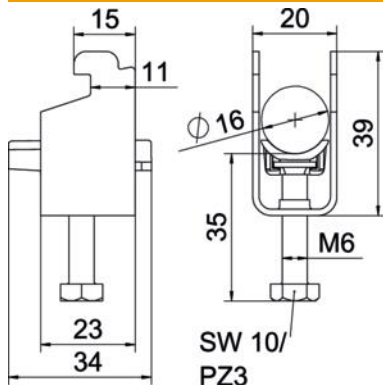

Length	22.5 mm
Width	20 mm
Height	39 mm
Plate thickness	1.5 mm
Dimension A	22.5 mm
Dimension B	20 mm
Dimension C	34 mm
Dimension G (mm)	M6
Dimension H	39 mm
Dimension L	35 mm
Dimension t	1.5 mm

Technical data

Number of cables/pipes	1
for rail with slot width (with interval), max.	12 mm
for rail with slot width (with interval), min.	11 mm
Thread	M6
Halogen-free	yes
Length of external dimensions	34 mm
Max. Tightening torque	3 Nm
With plastic trough	yes
Mounting type	Profile rail
Slot width	10 mm
Clamping range D, max.	16 mm
Clamping range D, min.	12 mm
Surface addition	Untreated
Material addition	Rustproof steel
With counter-trough	no
Material of trough	Plastic
Material quality of trough	Polypropylene